



# UNDER- COUNTER/WORK TOP FREEZERS

CONTACT US:

**Customer Service:**  
+1 (786) 5847439

**Sales Team:**  
+1 (786) 8602528

**Email:**  
sales@lfsusa.store

[www.lfsusa.store](http://www.lfsusa.store)



## COMPETITOR SERIES®



C-U27F-HC



C-U48F-HC



C-U60F-HC

# UNDER-COUNTER/WORK TOP FREEZERS

- Beautiful ergonomic construction & rounded corners
- Digital temperature controller and read-out
- All stainless steel exterior and interior
- Forced air refrigeration system
- Recessed door handles
- Pre-installed casters and shelving
- 90 degree hold open door feature for loading products
- Optional Accessory: Backsplash for Work-Tops for in-the-field installment\*\*, Taller 6" casters available\*\*\*
- All Natural R290 Hydrocarbon Refrigerant
- US Department of Energy Certified
- Migali® Protection Plan: 2 Year Parts & Labor Warranty, 5 Years Compressor Warranty

Latam Food Service

MODEL	DOORS	CAPACITY CU/FT	SHELVES	H/P	AMPS	VOLTAGE	ENERGY CONSUMPTION KWH/24 HR	PLUG TYPE	TEMP RANGE	EXTERIOR DIMENSIONS W X D X H*	INTERIOR DIMENSIONS W X D X H	PACKAGED DIMENSIONS W X D X H	WEIGHT	PACKAGED WEIGHT
C-U27F-HC	1	6.5	2	1/5	1.8	115/60/1	2.7	Nema 5-15P	-7° F (-) 3° F	27.5 x 30 x 34.1	23.9 x 23.6 x 26.7	29 x 32 x 39	146 lbs.	179 lbs.
C-U48F-HC	2	12	4	1/4+	2.6	115/60/1	4.1	Nema 5-15P	-7° F (-) 3° F	48.25 x 30 x 34.1	44.7 x 23.6 x 26.7	50 x 32 x 39	203 lbs.	245 lbs.
C-U60F-HC	2	17.9	4	1/4+	2.6	115/60/1	4.9	Nema 5-15P	-7° F (-) 3° F	60.25 x 30 x 34.1	56.7 x 23.6 x 26.7	63 x 32 x 39	230 lbs.	276 lbs.

\* Total height includes casters

\*\*Accessories: Stainless Steel Back Splash - BS27 - 27" wide / BS48 - 48" wide / BS60 - 60" wide

\*\*\* Optional 6" casters available - Part # 1759-208

FOR COMMERCIAL USE ONLY

NOTE: MIGALI® RESERVES THE RIGHT TO CHANGE SPECIFICATIONS WITHOUT NOTICE



TOLL FREE: 800.852.5292  
WEB: [www.migali.com](http://www.migali.com)



# DIMENSIONAL DRAWINGS

C-U27F-HC

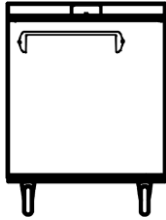

C-U48F-HC

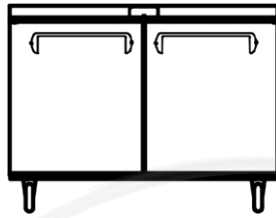

C-U60F-HC

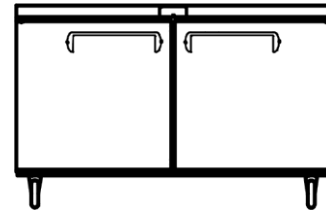

C-U27F-HC  
TOP VIEW

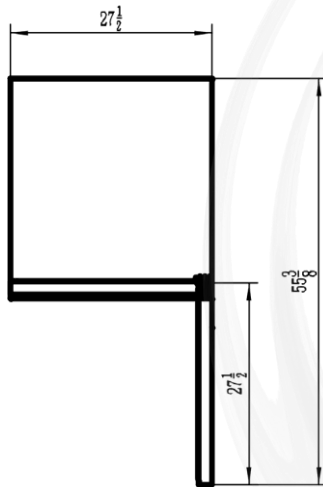

C-U48F-HC  
TOP VIEW

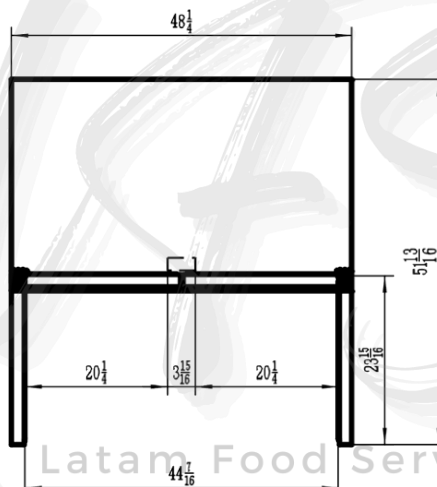

C-U60F-HC  
TOP VIEW

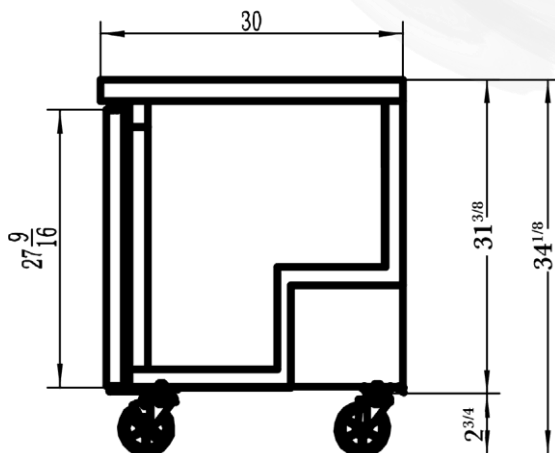
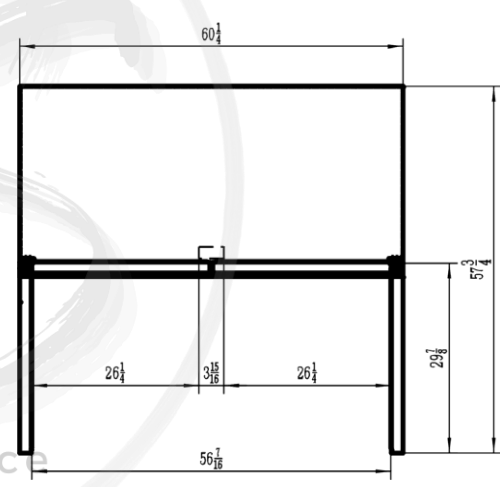

SIDE VIEW (1,2,3) DOOR MODELS



MIGALI® REMAINS AN AMERICAN FAMILY COMPANY SINCE 1955